

**Ersatzteilliste • Spare Parts List**



ME 3418  
8 636 595 493



S 3318  
8 928 264 011

**Release Panel**

ME 3401  
8 619 003 329

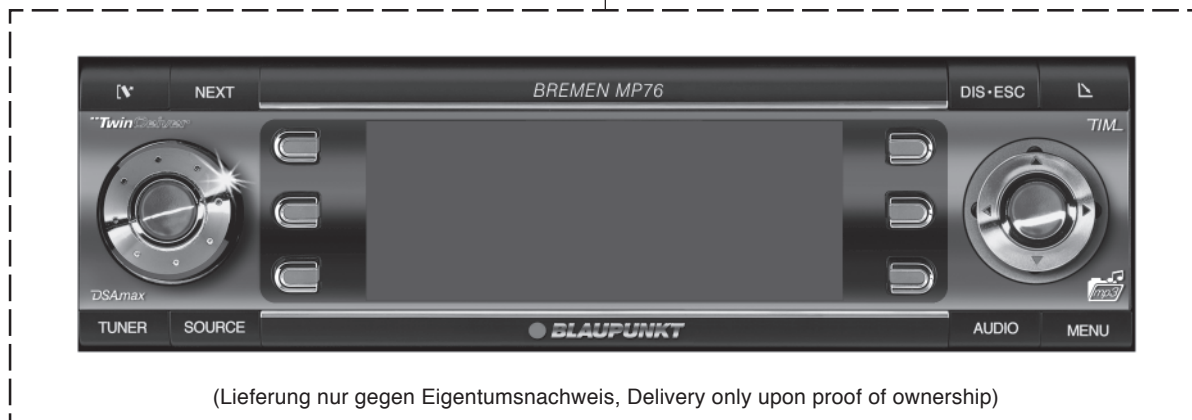

(D)

**ZUBEHÖR**

ME 1	DEMONTAGEBUEGEL
ME 2	ANTENNENSTECKER
ME 5	BUCHSENHALTER
ME 6	DISTANZBOLZEN
ME 7	FÜHRUNGSBOLZEN
ME 0020	STECKERGEHÄUSE
ME 3011	STYROPOR (2x)
ME 3013	FALTSCHACHTEL
ME 3988	EINBAURAHMEN
ME 3932	KLEBESCHILD "SECURITY"
ME 3993	ETUI
ME 3994	MIKROFON
ME 3995	MIKROFONKABEL (Anschluß)
ME 3996	MIKROFONKABEL (Verlängerung)
ME 4000	ANTENNE

**GEHÄUSETEILE**

ME 2020	SICHERUNG (10A)
ME 2050	ANSCHLUßKASTEN
ME 3140	DECKEL OBEN
ME 3142	DECKEL UNTEN
ME 3143	ISOLIEREINLAGE
ME 3200	TORX-SCHRAUBE (2,5x6) (8x)
ME 3202	TORX-SCHRAUBE (4x8) (2x)
ME 3204	TORX-SCHRAUBE (2x3) (schwarz)
ME 3540	RASTFEDER (2x)

(GB)

**ACCESSORIES**

DISMANTLING AID	8 601 910 003
ANTENNA PLUG	8 908 603 224
JACK HOLDER	8 600 660 019
SPACER PIN	8 603 160 008
GUIDE PIN	8 600 460 050
PLUG HOUSING	8 600 360 165
STYROFOAM (2x)	8 635 460 511
DISPLAY BOX	8 635 432 747
ASSEMBLY FRAME	8 601 310 800
STICKER "SECURITY"	8 631 110 160
CASE	8 635 260 391
MICROPHONE	8 636 696 081
MICROPHONE CABLE (connection)	8 634 494 317
MICROPHONE CABLE (extension)	8 634 494 316
ANTENNA	8 672 001 805

**HOUSING PARTS**

FUSE (10A)	8 943 999 019
TERMINAL BOX	8 634 392 896
TOP COVER	8 635 130 083
BOTTOM COVER	8 636 562 178
INSULATOR INSERT	8 631 058 960
TORX-SCREW (2,5x6) (8x)	8 633 410 572
TORX-SCREW (4x8) (2x)	8 633 410 649
TORX-SCREW (2x3) (black)	8 633 410 951
STOP SPRING (2x)	8 631 210 630

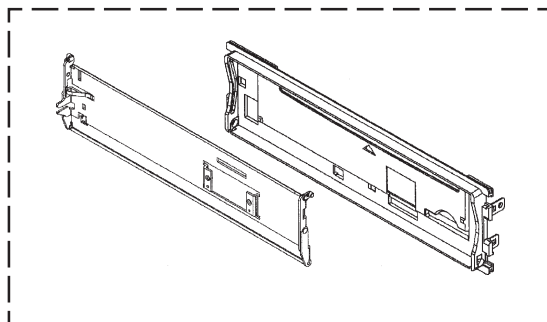

ME 1320  
8 619 003 330

ME 3404 kompl.  
8 619 002 545

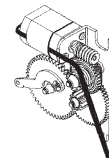

**RELEASE PANEL**

ME 1001	LC-DISPLAY
ME 3210	TORX-SCHRAUBE (1,8x12) (4x)
ME 3401	DEKORPLATTE OBEN
ME 3402	DEKORPLATTE UNTEN
ME 3591	RÜCKWAND

**RELEASE PANEL**

LC-DISPLAY	8 945 406 832
TORX-SCREW	8 633 410 754
DECOR-PLATE TOP	8 613 150 015
DECOR-PLATE BOTTOM	8 631 174 045
REAR PANEL	8 613 590 033

ME 3415  
8 632 065 379

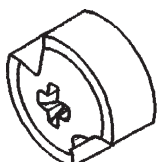

ME 3846  
8 635 620 096

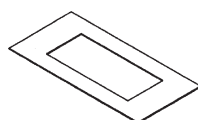

ME 3604  
8 632 160 030



ME 3215  
8 613 530 010



ME 3216  
8 632 160 023



**SCHALTERPLATTE**

ME 3352	SCHALTMATTE RECHTS
ME 3353	SCHALTMATTE LINKS

**SWITCH BOARD**





KEYPAD RIGHT	8 638 840 256
KEYPAD LEFT	8 638 840 317





**CD-LAUFWERK**

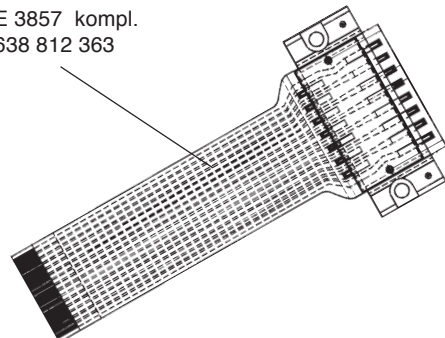

ME 3750	STEUERPLATTE
ME 5001	CD-LAUFWERK



**CD DRIVE MECH.**

DISTRIBUTION PLATE	8 638 812 647
CD-DRIVE MECH.	8 638 812 707

Position Position	Bezeichnung Designation	Bestell-Nr. Part no.
ME 3600	<b>SCHALTERPLATTE, SWITCH BOARD</b> ( 8 638 202 461 = kein E.T / no spare part )	
		
D 901	ST 72 F321	8 611 200 555
D 1001	74 HC 14PW	8 928 906 437
D 1002	LM 224 DR	8 928 906 473
D 1003	LM 224 DR	8 928 906 473
D 1004	LM 50 CIM	8 928 906 360
		
H 2700	LBT 773	8 928 510 149
H 2701 -		
H 2714	LSG T671	8 928 510 150
H 2715	LBT 676	8 928 510 151
H 2716	LBT 676	8 928 510 151
H 2723 -		
H 2728	LAT BG66B	8 928 510 143
		
S 3318	ENCODER	8 928 264 011
		
V 1005	UMD 3N	8 928 710 010
V 1006	BZX 84C22	8 928 620 031
V 1007	BC 847 C	8 928 710 049
V 1008	BAV 99	8 928 610 024
V 1009	BAV 99	8 928 610 024
V 1012	BC 817-40	8 928 710 007
V 1024	DTC 143 ZKA	8 928 710 009
V 2701 -		
V 2728	BC 847 C	8 928 710 049
V 7900 -		
V 7909	BAV 99	8 928 610 024
V 7910	BZX 84/C3V3	8 928 620 004
		
Z 900		8 926 310 112
	<b>MECHANISCHE TEILE, MECHANICAL PARTS</b>	
X 1010	KONTAKTLEISTE (15 PIN) CONTACT STRIP	8 638 801 574
		
	ME 3857 kompl. 8 638 812 363	

Position Position	Bezeichnung Designation	Bestell-Nr. Part no.
ME 3599	<b>HAUPTPLATTE, MAIN BOARD</b> ( 8 638 202 460 = kein E.T / no spare part )	
		
C 2061	3300 µF	8 928 160 012
C 2108	2200 µF	8 928 160 016
		
D 160	PC 540207 FU	8 928 906 364
<b>D 800</b>	<b>UPD 70F3068</b>	<b>8 611 200 725</b>
D 810	74 VHC 74MTC	8 928 906 871
D 910	M 95640	8 928 906 480
D 940	74 LVC 16373	8 928 906 345
<b>D 950</b>	<b>AM 29LV800 BB</b>	<b>8 611 200 776</b>
D 960	74 LVC 139PW	8 928 906 425
D 1450	MC 33079 DT	8 928 906 475
D 1500	PC 540205 FU	8 928 906 365
D 1550	MC 33079 DT	8 928 906 475
D 1551	MC 33078 DR2	8 928 907 154
D 1600	TDA 7386	8 928 906 383
D 1802	74 AHCT1G125	8 928 906 476
D 1803	74 HC 14PW	8 928 906 437
D 1804	74 HC 14PW	8 928 906 437
D 2000	LD 1085 P	8 928 996 004
D 2002	LD 1085 P	8 928 996 004
D 2010	L 4949	8 928 906 472
D 2012	LMC 7660 IMX	8 928 906 836
D 2030	TLE 4274 GSV	8 928 906 477
D 2140	L 5953	8 928 906 381
D 2150	TA 8409 F	8 928 907 155
D 2301	DSPB 56367 PV	8 928 906 606
<b>D 2302</b>	<b>AM 29LV800 BB</b>	<b>8 611 200 776</b>
D 2304	TC 7S04 FU	8 928 907 159
D 7900	74 LVC 1G125	8 928 906 481
D 7901	74 AHCT 125P	8 928 906 402
D 8700	STA 016A	8 928 906 479
D 8701	74 LVC247 APW	8 928 906 426
		
H 800	LOT 670	8 928 510 110
		
L 131		8 928 420 027
L 132		8 928 420 027
L 133		8 928 420 028
L 134		8 928 420 028
L 135		8 928 420 027
L 140		8 928 420 030
L 141		8 928 420 029
L 142		8 928 420 029
L 145		8 928 420 030
L 150		8 928 420 031
L 151		8 928 420 031
L 152		8 928 420 010
L 153		8 928 420 009
L 154		8 928 420 009
L 155		8 928 420 009
L 800		8 928 440 005
L 820		8 928 440 005
L 830		8 928 440 005
L 870		8 928 440 005
L 880		8 928 440 005
L 881		8 928 440 005
L 1500		8 928 420 031
L 1501 -		
L 1504		8 928 420 009
L 1505		8 928 420 010

Position Position	Bezeichnung Designation	Bestell-Nr. Part no.
L 1506		8 928 420 010
L 1507		8 928 440 007
L 2140		8 928 430 004
L 2141		8 928 430 005
L 2300 -		
L 2307		8 928 440 005
L 7901 -		
L 7925		8 928 440 005
		
S 2150		8 638 802 066
S 2151		8 638 802 095
		
V 805	LS 4148	8 928 610 020
V 806	BC 848 C	8 928 710 005
V 807	BAV 99	8 928 610 024
V 1456	BC 856 B	8 928 710 043
V 1457	BC 848 C	8 928 710 005
V 1458	LS 4148	8 928 610 020
V 1625	DTA 124 EKA	8 928 710 045
V 1626	LS 4148	8 928 610 020
V 1630	DTC 314 TK	8 928 710 034
V 1631 -		
V 1637	DTC 314 TK	8 928 710 034
V 1638	DTA 124 EKA	8 928 710 045
V 1639	LS 4148	8 928 610 020
V 1648	BC 848 C	8 928 710 005
V 1800	BZX 84/C5V6	8 928 620 018
V 1802	BZX 84/C12	8 928 620 014
V 1805	BZX 84/C3V9	8 928 620 009
V 1806	BZX 84/C3V9	8 928 620 009
V 1807	BZX 84/C5V6	8 928 620 018
V 1808	LS 4148	8 928 610 020
V 1809	DTC 124 XKA	8 928 710 044
V 1810	BZX 84/C3V9	8 928 620 009
V 1811	BZX 84/C3V9	8 928 620 009
V 1812	BZX 84/C3V9	8 928 620 009
V 1820	BAV 99	8 928 610 024
V 1830	BAV 99	8 928 610 024
V 2000	DTC 143 ZKA	8 928 710 009
V 2001	MTD 20PP06 HD	8 928 710 245
V 2002	BZX 84/C12	8 928 620 010
V 2012	S 1 G	8 928 610 008
V 2013	BYS 10-45	8 928 610 118
V 2030	UMD 3N	8 928 710 110
V 2031	UMD 3N	8 928 710 110
V 2032	LS 4148	8 928 610 020
V 2033	DTC 143 ZKA	8 928 710 009
V 2034	UMD 3N	8 928 710 110
V 2035	UMD 3N	8 928 710 110
V 2084	BAV 99	8 928 610 024
V 2085	DTC 124 XKA	8 928 710 044
V 2086	DTC 124 XKA	8 928 710 044
V 2087	BC 858 C	8 628 710 006
V 2088	DTC 124 XKA	8 928 710 044
V 2089	BCX 53-16	8 928 710 041
V 2090	BC 807-40	8 928 710 010
V 2091	DTC 143 ZKA	8 928 710 009
V 2100	BAV 99	8 928 610 024
V 2101	BAV 99	8 928 610 024
V 2102	BC 848 C	8 928 710 005
V 2103	BZX 84/C12	8 928 620 010
V 2104	BZX 84/C12	8 928 620 010

Position Position	Bezeichnung Designation	Bestell-Nr. Part no.
V 2105	LS 4148	8 928 610 020
V 2106	STP 36NE06 F	8 928 710 021
V 2140	S 1 G	8 928 610 008
V 2141	LS 4148	8 928 610 020
V 2143	S 1 G	8 928 610 008
V 2142	BYS 10-45	8 928 610 118
V 2144	S 1 G	8 928 610 008
V 2305	BZX 84/C3V9	8 928 620 009
V 7902	BZX 84/C5V6	8 928 620 018
V 7902	BZX 84/C5V6	8 928 620 018
V 7902	BZX 84/C5V6	8 928 620 018
V 7903	BZX 84/C3V9	8 928 620 009
V 7904	BAV 99	8 925 405 124
V 7905 -		
V 7907	BZX 84/C5V6	8 928 620 018
V 7908	BZX 84/C3V9	8 928 620 009
V 7909	BC 848 C	8 928 710 005
V 7911	BAV 99	8 928 610 024
V 7912	BAV 99	8 928 610 024
		
Z 150		8 928 310 037
Z 800		8 928 310 094
Z 801		8 928 310 108
Z 8700		8 928 310 048
<b>MECHANISCHE TEILE, MECHANICAL PARTS</b>		
A 0001	ANTENNEN PLATTE ANTENNA PLATE	8 638 202 462
A 0200	TWIN-TUNER TWIN-TUNER	8 638 812 284
A 0300	SD-KARTENLESER SD-CARD_READER	8 619 003 331
X 1000	KONTAKTLEISTE (15 PIN) CONTACT STRIP	8 638 802 029
X 5100	FLACHLEITUNG FLAT RIBBON CABLE	8 634 450 096
<b>Hinweis:</b> Handelsübliche Teile sind nicht in der Ersatzteilliste aufgeführt. Wir bitten Sie, diese Teile im Fachhandel zu beziehen.		<b>Note:</b> Conventional components are not included in the spare part list. Please purchase them from a specialist dealer.

**Blaupunkt GmbH, Robert-Bosch-Str. 200, D-31139 Hildesheim**